

**MO 10/2**

**MO 10/3**

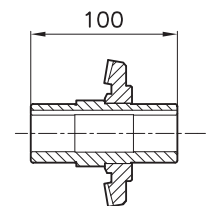
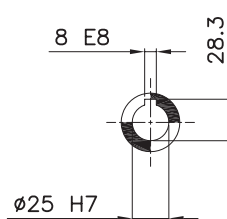
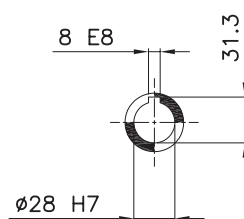
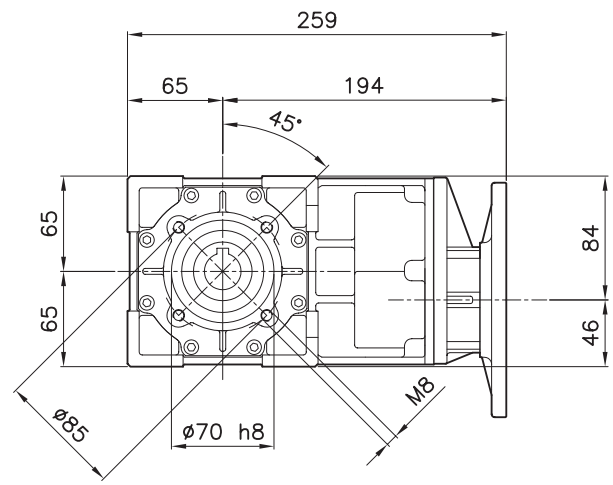
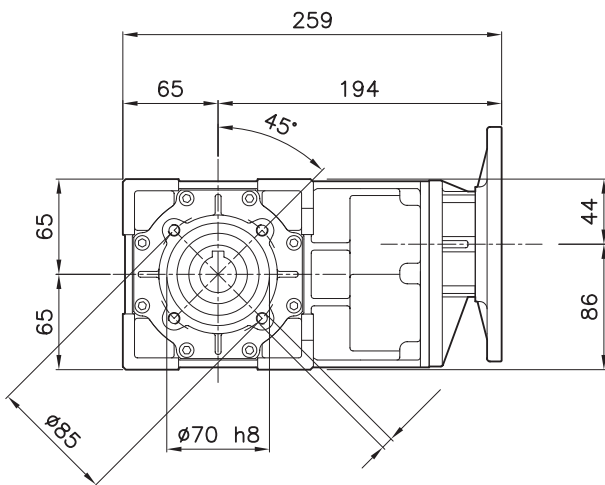
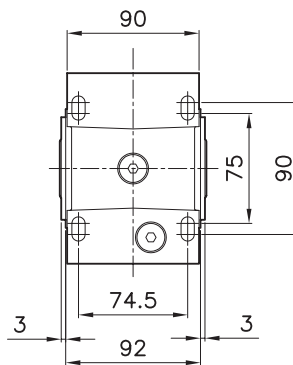
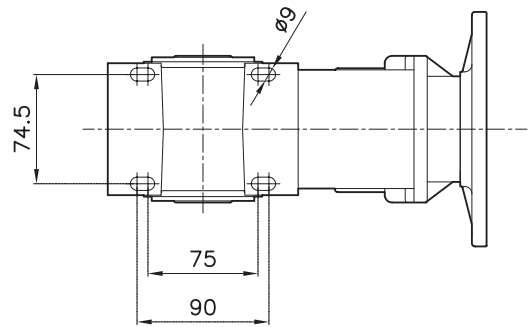
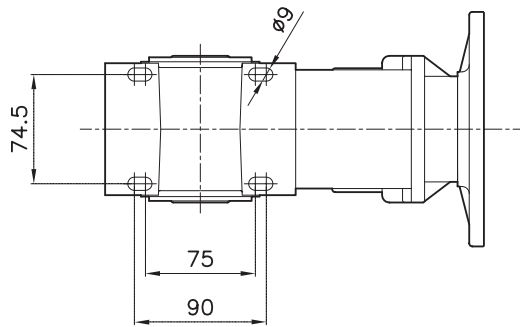

**A richiesta**

Optional - Auf Wunsch  
Sur demande - A pedido

**Standard**

Standard - Standard  
Standard - Estandar